

# LEDVANCE® MOON

## 10W, 16W, 20W 100-220V

## 3000K, 6500K



### Benefícios

- ✓ Placa de LED integrada com proteção
- ✓ Fácil instalação;
- ✓ Luminosidade homogênea sem pontos destacados de LED.

**ECONOMIA**

**60%**

**VIDA ÚTIL**  
**25.000h**



### Aplicação



Ambientes  
Residenciais



Corredor



Loja



Quarto



Sala



Saiba como instalar as nossas luminárias acessando o nosso canal no **Youtube LEDVANCE**.

## Ficha técnica do produto

Potência nominal	10W, 16W, 20W
Equivalência	10W: 1x CFLi 15W   16W e 20W: 2x CFLi 23W
Tensão nominal	100-240V
Fluxo luminoso	<b>10W:</b> 800lm <b>16W:</b> 1200lm <b>20W:</b> 1800lm
Eficiência em lm/W	80lm/W
Temperatura de cor	3000K, 6500K
Índice de Reprodução de cor (IRC)	>80
Fator de Potência	0.6
Ângulo de Abertura	100°
Vida útil	25.000h
Dimerizável	Não
Grau de Proteção	IP20
Temperatura mínima e máxima de trabalho	-10~... + 40°C
Temperatura mínima e máxima de armazenagem	-20~... + 70°C
Garantia	3 anos

## Desenho técnico

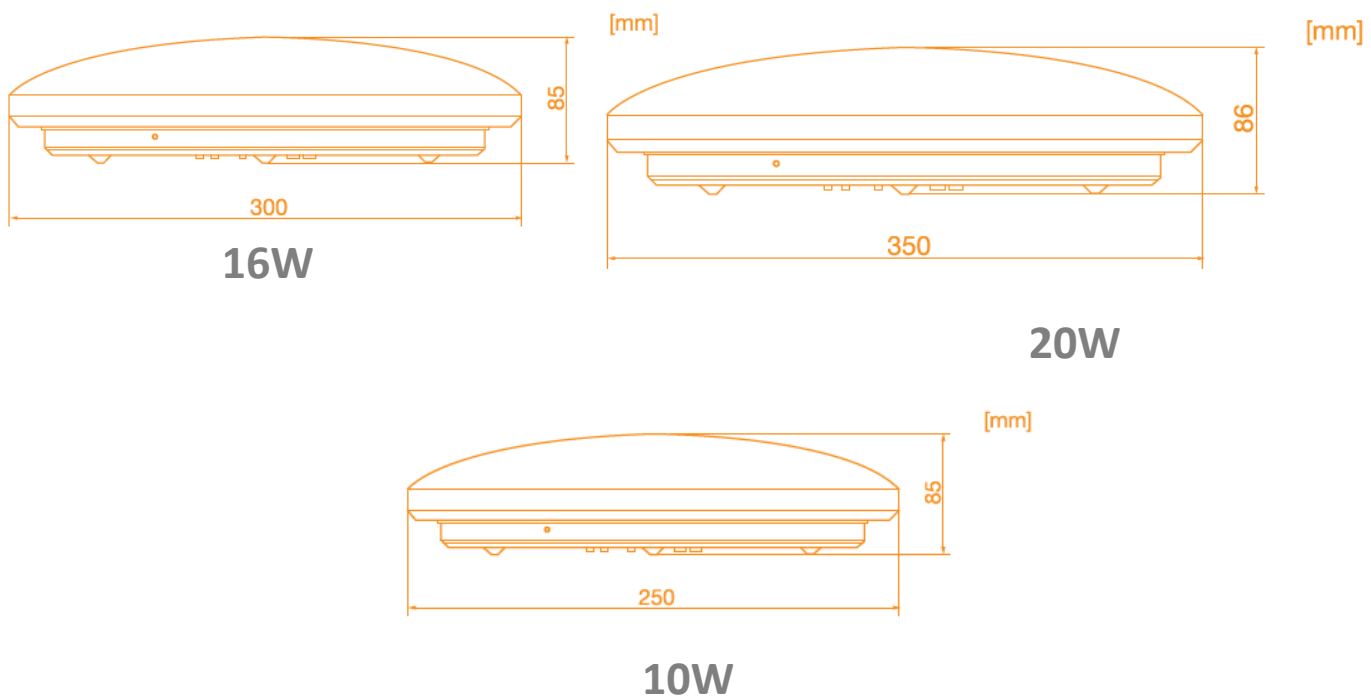

## Dados logísticos

Código SAP	Descrição	EAN 10	EAN 40	Peso líquido do produto (g)
7014421	LEDVANCE MOON 10W/830 BIV	4058075066779	4058075066786	335
7014422	LEDVANCE MOON 10W/865 BIV	4058075066793	4058075066809	335
7014423	LEDVANCE MOON 16W/830 BIV	4058075066816	4058075066823	495
7014424	LEDVANCE MOON 16W/865 BIV	4058075066830	4058075066847	495
7014425	LEDVANCE MOON 20W/830 BIV	4058075066854	4058075066861	660
7014426	LEDVANCE MOON 20W/865 BIV	4058075066878	4058075066885	660

Código SAP	Dimensional EAN10 (mm)	Peso EAN 10(g)	Dimensional EAN40 (mm)	Peso EAN 40 (g)	Quantidade por caixa
7014421	275x90x275	483	4750x2950x2900	3300	5
7014422	275x90x275	483	4750x2950x2900	3300	5
7014423	325x90x325	678	4750x3450x3400	4500	5
7014424	325x90x325	678	4750x3450x3400	4500	5
7014425	375x90x375	883	4750x3950x3900	5780	5
7014426	375x90x375	883	4750x3950x3900	5780	5

## Diagrama Fotométrico

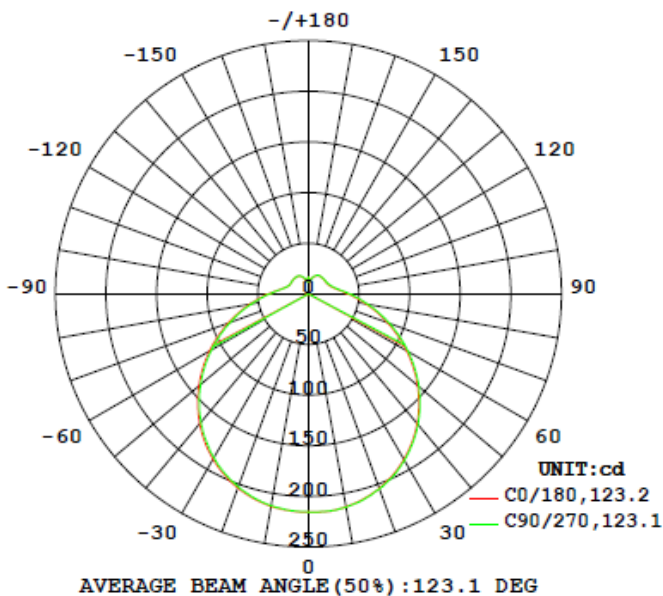

## Curva Iluminância-Distância

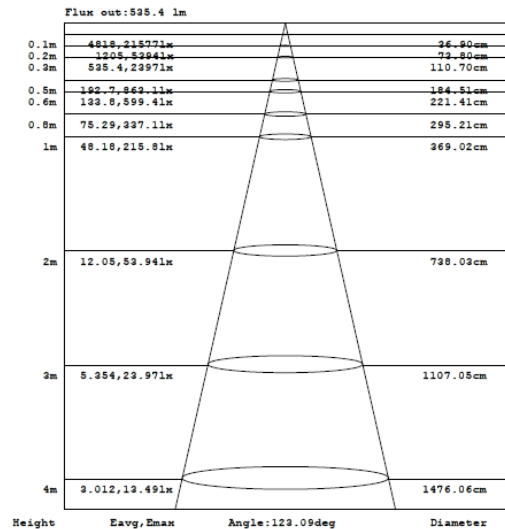

# 10W

## Diagrama Fotométrico

## Curva Iluminância-Distância

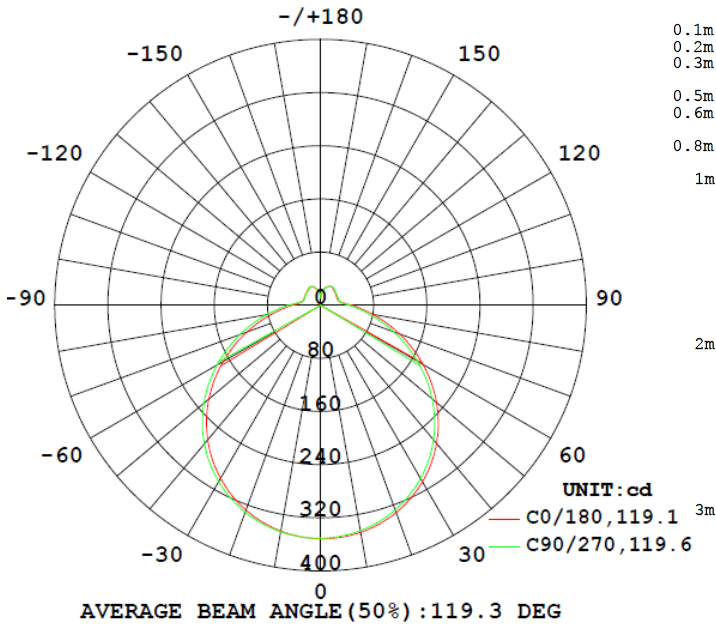

Flux out: 823.8 lm

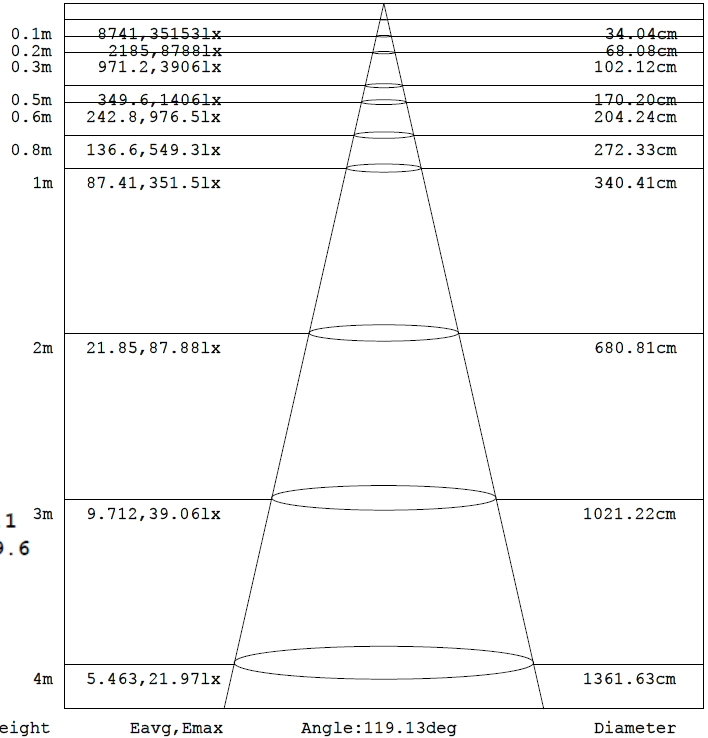

# 16W

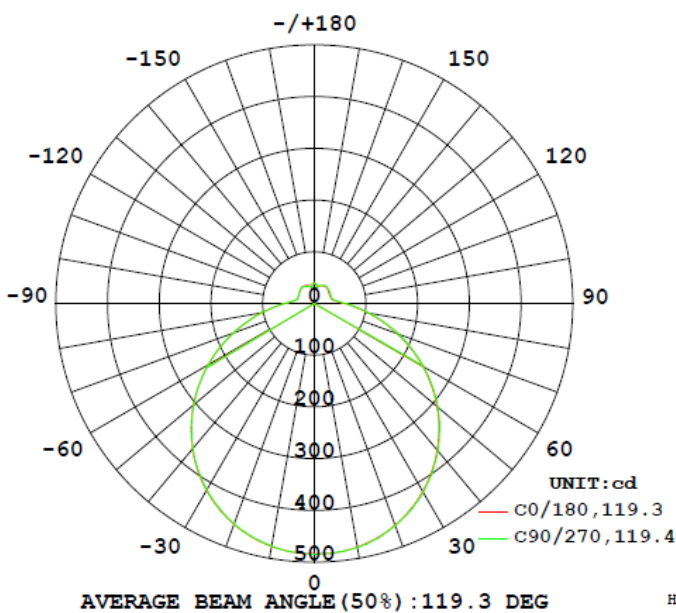

Flux out: 1135 lm

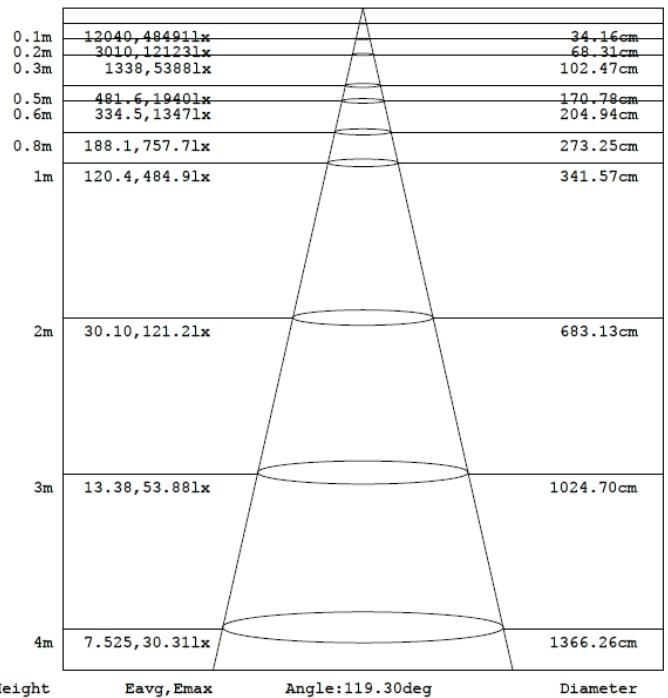

# 20W