

Light is OSRAM

WIDE TRACK System

Wide Track 8 mm height
FX-QMW-G1-TU26H8-300



Features & Benefits

Perfectly diffuse and homogeneous lighting to add a cool atmosphere to any space. Thanks to its reduced height and its accessories for recessed mounting, this wide track is ideal for surface or embedded lighting in suspended ceiling.

Application

- Architectural integration
- Cove lighting
- Recessed lighting

Dimension & Available Covers

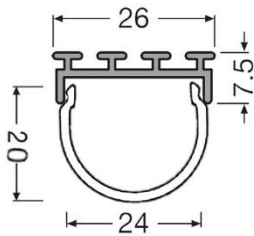

Wide Track +
Wide cover round frosted matte
FX-QMW-G1-CRD-300



Wide track + Wide cover round frosted matte

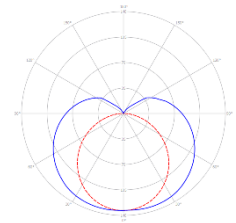

— C0-C180 cd/1000lm
— C90-C270
Wide cover round frosted matte

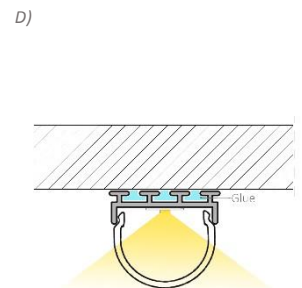
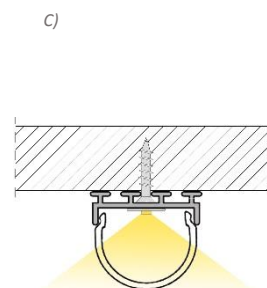
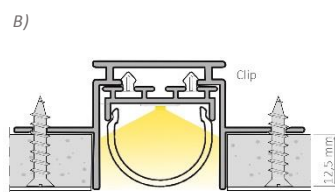
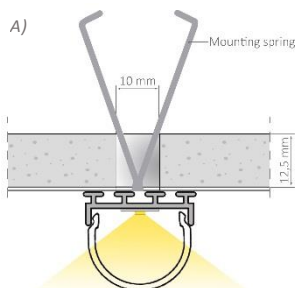











A); B) Application example – Drywall [A) metal spring; B) mounting profile]









C); D) Application example – Other ways of mounting [C) screw; D) glue]









Wide track and strip LF1200 with and without wide cover round frosted matte





Electrical & Output data

TRACK & LED STRIP COMPATIBILITY ¹							
LED Strip WHITE			LF200	LF06A	LF800S	LF1200	LF1200 TW
Color Temperature			Luminous Flux (lm/m) ²				
	820	2000 K White	-	-	-	1000	-
	824	2400 K White	-	380	800	1200	-
	827	2700 K White	200	390	800	1200	-
	830	3000 K White	200	390	800	1200	-
	840	4000 K White	200	425	850	1200	-
	850	5000 K White	-	425	850	1200	-
	865	6500 K White	200	425	850	1200	-
	CRI 90 927	2700 K White	-	-	-	1100	-
	CRI 90 930	3000 K White	-	-	-	1200	-
	CRI 90 940	4000 K White	-	-	-	1200	-
	TW	2700 - 6500 K Dynamic White	-	-	-	-	1200

LED Strip COLOR		LF200M	LF200C	LF05A2	LF05CA2	LF700RGBW	LF71300RGBW
Color Temperature		Luminous Flux (lm/m) ²					
	R 625 Red	140	-	120	-	-	-
	G 525 Green	157	-	180	-	-	-
	B 467 Blue	-	-	80	-	-	-
	B 470 Blue	48	-	-	-	-	-
	Y 587 Yellow	140	-	110	-	-	-
	O 602 Orange	-	-	130	-	-	-
	RGB RGB RGB	-	209	-	470	-	-
	RGBW RGBW RGBW	-	-	-	-	697*	1293*

*Both channels RGB and White on

TRACK & LED STRIP IP67 COMPATIBILITY ¹						
LED Strip WHITE IP67			LF06E-P	LF06A-P	LFP800S	
Color Temperature			Luminous Flux (lm/m) ²			
	827	2700 K White	-	400	-	-
	830	3000 K White	190	390	-	860
	840	4000 K White	200	390	-	860
	856	5600 K White	-	-	-	810
	870	7000 K White	-	420	-	-
	880	7600 K White	190	-	-	810

LED Strip COLOR IP67		LFP200M	LF05A-P	LFP200C	LF05CA-P
Color Temperature		Luminous Flux (lm/m) ²			
	R 625 Red	140	-	-	-
	G 522 Green	157	-	-	-
	B 467 Blue	48	80	-	-
	Y 587 Yellow	140	-	-	-
	RGB RGB RGB	-	-	180	435

¹ Compatibility tested in surface condition including cover at T amb=25°C. Tc of the LED strip has to be always checked (Tc<Tc max) due to dependence on the specific installation conditions. For further information contact our support service at flex-support@osram.com

² Luminous flux comprehensive of the track's efficiency without cover (Light Output Ratio 100%).
!Note: -35% with cover round frosted matte.

Technical drawings

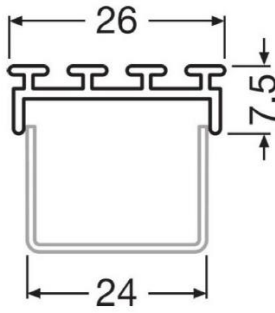

Wide Track
FX-QMW-G1-TU26H8-300
Order code 4052899448643

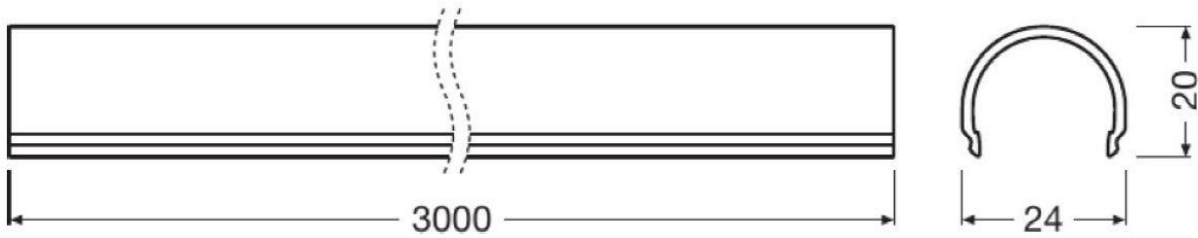

Wide cover round frosted matte
FX-QMW-G1-CRD-300
Order code 4052899447035

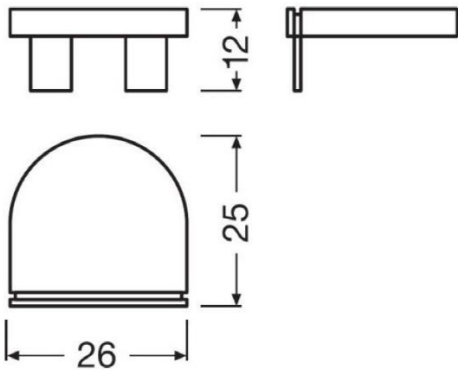

Plastic Round end cap grey plain
FX-QMW-G1-ERGP-TU26H8
Order code 4052899450271

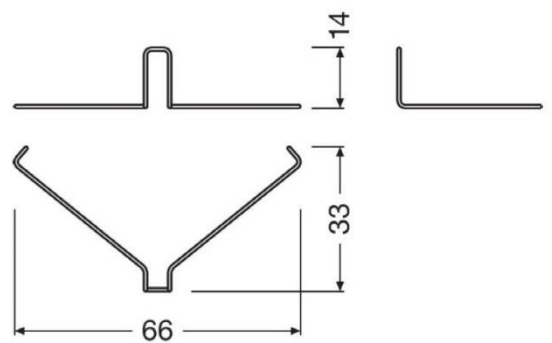

Mounting spring metal
FX-QMW-G1-SMME-DIV1
Order code 4052899446830

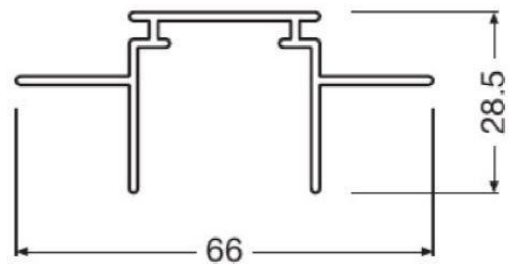
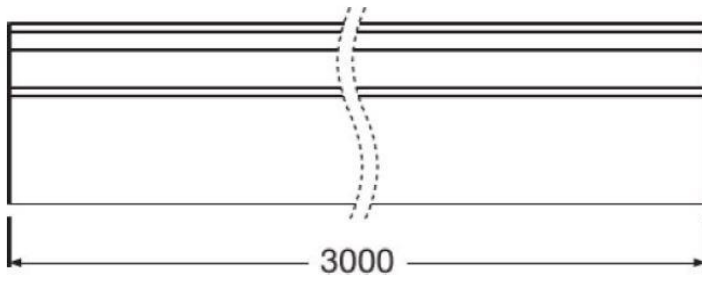

Mounting profile metal
FX-QMW-G1-P125C30-DIV1-300
Order code 4052899449060

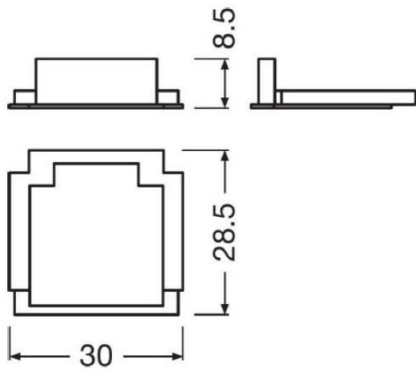

Plastic End cap for mounting profile
FX-QMW-G1-EFGP-PC30
Order code 4052899450165

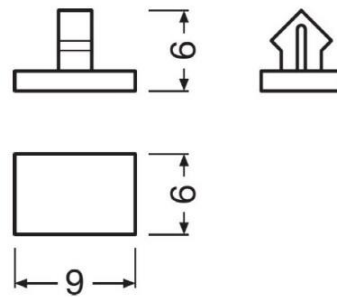

Plastic Clip for combining track and mounting profile
FX-QMW-G1-XCLPL1-DIV1
Order code 4052899446731

Track System Order Code

Product Code	Description	Product Number (EAN10)	Dimensions (length x width x height)	EAN Package content
FX-QMW-G1-TU26H8-300	Wide Track 8 mm height	4052899448643	3000 x 45.6 x 26.7 mm	1x Wide Track
FX-QMW-G1-CRD-300	Wide cover round frosted matte	4052899447035	3000 x 24 x 20 mm	1x Cover
FX-QMW-G1-ERGP-TU26H8	Round end cap grey plain	4052899450271	26 x 25 x 12 mm	40x End cap
FX-QMW-G1-SMME-DIV1	Mounting spring metal	4052899446830	66 x 33 x 14 mm	40x Mounting spring
FX-QMW-G1-P125C30-DIV1-300	Mounting profile metal	4052899449060	3000 x 66 x 28.5 mm	1x Mounting profile
FX-QMW-G1-EFGP-PC30	End cap for mounting profile	4052899450165	30 x 28.8 x 8.5 mm	40x End cap
FX-QMW-G1-XCLPL1-DIV1	Clip for combining track and mounting profile	4052899446731	9 x 6 x 6 mm	40x Clip

Complete System Example

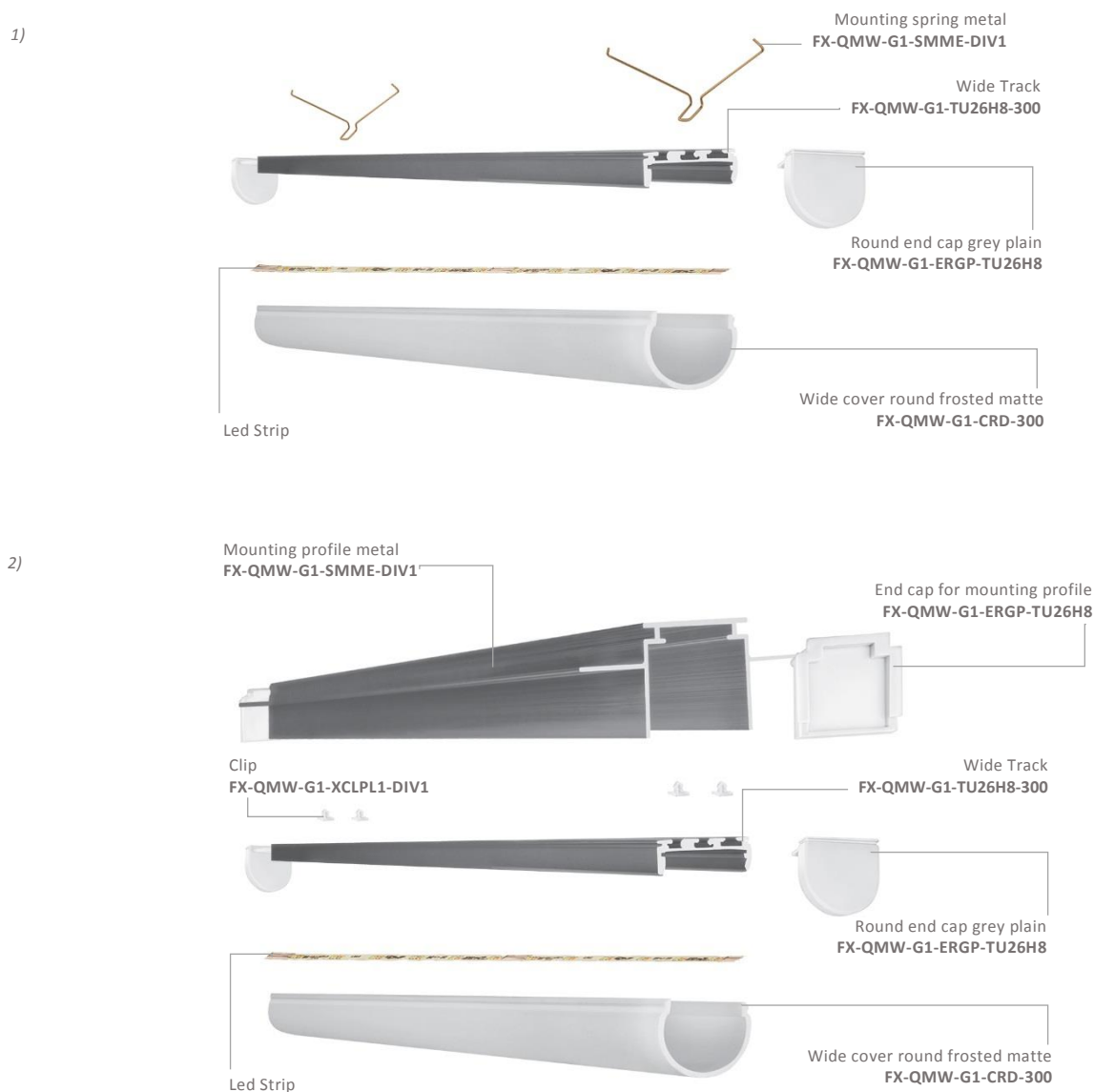

For further information please write to flex-support@osram.com or consult our Flex Configurator at <https://flex.osram.info/en/flex-configurator>

Disclaimer

Subject to change without notice. Errors and omission excepted. Always make sure to use the most recent release.

OSRAM GmbH

Head Office:

Marcel-Breuer-Strasse 6
80807 Munich, Germany
Phone +49 89 6213-0
Fax +49 89 6213-2020
www.osram.com

OSRAM