







Installation Instructions

SubstiTUBE®

T8

T5

Portfolio

Product line	SubstiTUBE® EM	SubstiTUBE® Universal	SubstiTUBE® HF
T8			
Compatibility	Electromagnetic driver (EM/CCG) and line voltage (220-240V)	Electromagnetic driver (EM/CCG) High frequency / electronic driver (HF/ECG) and line voltage (220-240V)	High frequency / electronic driver (HF/ECG). Operation with ECG in luminaire only!
Product line	SubstiTUBE® HF	SubstiTUBE® AC	
T5			
Compatibility	High frequency / electronic driver (HF/ECG). Operation with ECG in luminaire only!	Line voltage (220-240V)	

Agenda

1. Installation options

1.1 Test

2. SubstiTUBE® T8 EM

2.1 Retrofitting in a CCG luminaire

2.1.1 Luminaires with compensating capacitor

2.1.2 Duo circuit lamp luminaire

2.1.3 Tandem operation

2.2 Conversion / Direct Wiring

2.2.1 Direct line voltage connection

2.2.2 Sample installation direct wiring

3. SubstiTUBE® T8 and T5 HF

3.1 Retrofitting in a ECG luminaire

3.2 Multi circuit lamp luminaire

4. SubstiTUBE® T8 Universal

4.1 Retrofitting in a CCG luminaire

4.1.1 Luminaires with compensating capacitor

4.2 Retrofitting in a ECG luminaire

4.3 Conversion / Direct Wiring

5. SubstiTUBE® T5 AC

5.1 Conversion / Direct Wiring

5.1.1 Direct line voltage connection

5.1.2 Sample installation direct wiring

1. Installation options

I) Retrofitting a CCG luminaire accord. to EN 62776

Replacing fluorescent T8-tube and installed starter by **SubstiTUBE®** EM T8 and **SubstiTUBE®** Start.

II) Conversion of an ECG or CCG luminaire

Rewiring of the luminaire necessary for replacing fluorescent tube by **SubstiTUBE®** EM in ECG luminaires. Rewiring is also possible for replacement by **SubstiTUBE®** EM in CCG luminaires. Installation must be done by qualified Electricians and all security precautions described herein must be followed. Please refer to chapter 2.2.2 “Sample installation direct wiring” for more details.

III) Retrofitting an ECG luminaire accord. to EN 62776

Replacing conventional fluorescent T8 tube by **SubstiTUBE®** HF T8. Before retrofitting, check driver compatibility list on www.ledvance.com/substiTUBE, as **SubstiTUBE®** HF has to be compatible with installed ECG.

Overview of possible installations

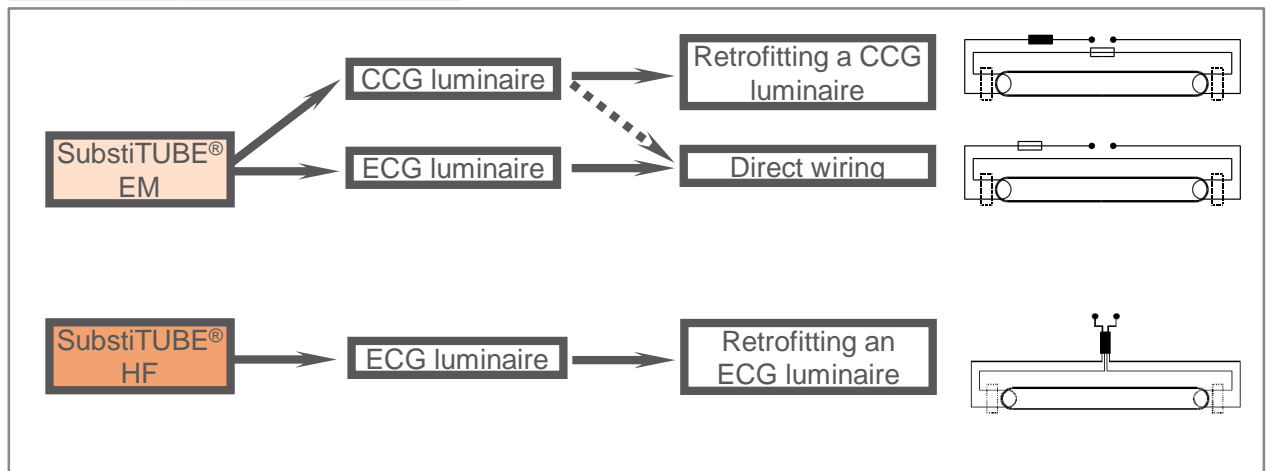

1. Installation options

1.1 Test

You are not sure whether you require a lamp for operation on a CCG or ECG? Two simple tests are available to quickly find the suitable product.

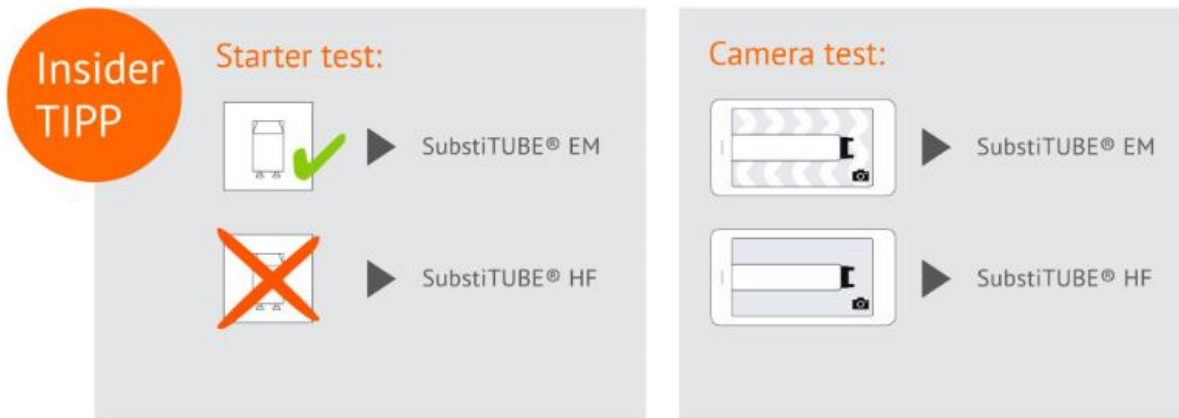

Starter test

Check whether the luminaire in which the new lamp should be used has a starter. If it has, you need a SubstiTUBE for operation on a CCG. If it doesn't have a starter, use the ECG-compatible variant.

Camera test

A functional T8 fluorescent lamp is still installed in the luminaire. Observe this through a digital camera (e.g. on your smartphone or tablet). If the light flickers, you need a SubstiTUBE for operation on a CCG. Otherwise, use the ECG-compatible variant.

2. EM-Types

2.1 Retrofitting in a CCG luminaire

2.1 Retrofitting in a CCG luminaire

Simple luminaire upgrade with a LED Tube. The fluorescent T8 lamp has to be exchanged by SubstiTUBE® EM T8 and the starter being replaced by SubstiTUBE® Start. The built-in CCG can be used as it is and existing certifications remain valid. Its losses are reduced to ohmic losses of usually about 1W.

Note: If the starter has not been changed to SubstiTUBE® Start the luminaire will start blinking. Please switch off immediately and change the starter, because SubstiTUBE® EM can be damaged. SubstiTUBE® EM can be used in luminaires with changeable starters only.

Retrofitting for common lamp holders

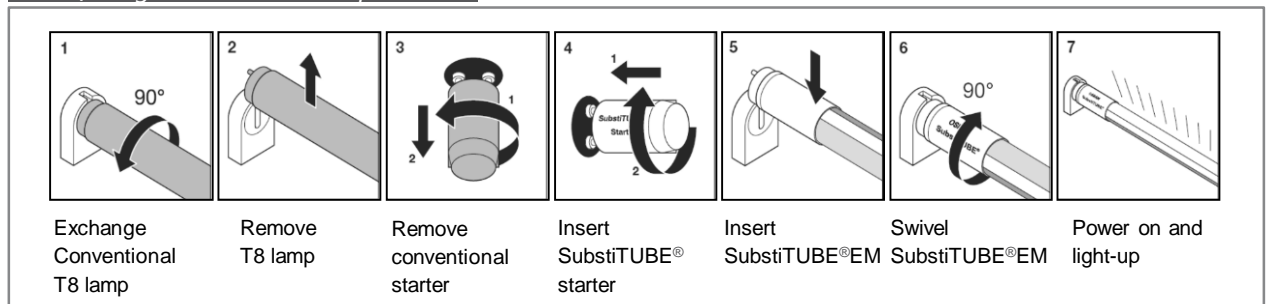

Note: SubstiTUBE® Start is necessary for operation.

2. EM-Types

2.1 Retrofitting in a CCG luminaire

2.1.1 Luminaires with compensating capacitors

SubstiTUBE® EM can be applied in luminaires with integrated compensating capacitors. The maximum possible amount of SubstiTUBE® EM in compensated luminaires operated at one circuit breaker can be found in the SubstiTUBE® product data sheet → download area at related product (www.ledvance.com/substitute).

Circuit diagram of a retrofitted CCG luminaire

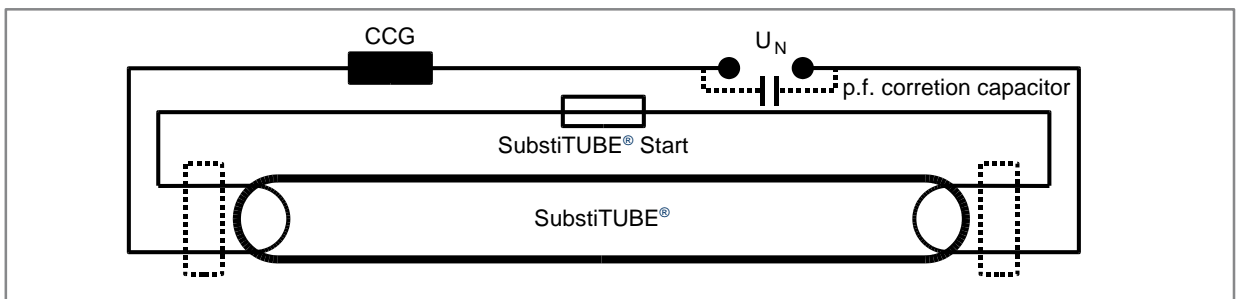

2.1.2 Duo circuit lamp luminaires with compensating capacitors

Double lamp luminaires can be refitted analogue to single lamp luminaires if they show duo circuit wiring according to below scheme.

Usage in tandem circuitry luminaires with serial wired lamps requires rewiring.

Circuit diagram of a retrofitted double lamp CCG luminaire

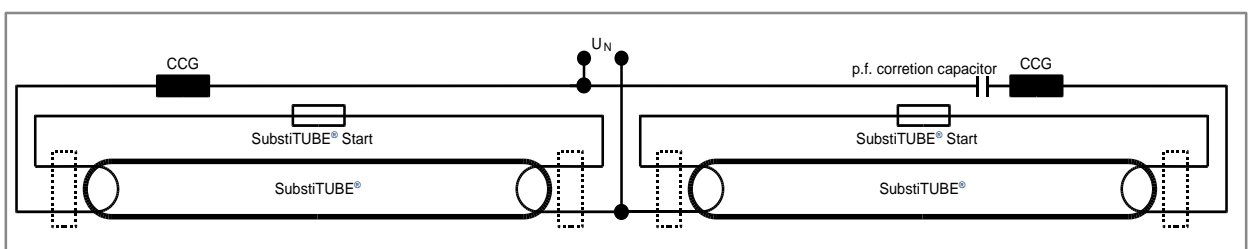

2. EM-Types

2.1 Retrofitting in a CCG luminaire

2.1.3 Tandem operation

SubstiTUBE® Advanced EM tubes (0,6M) are suitable for tandem operation, a circuit diagram is shown below.

Circuit diagram of a lamp in tandem operation

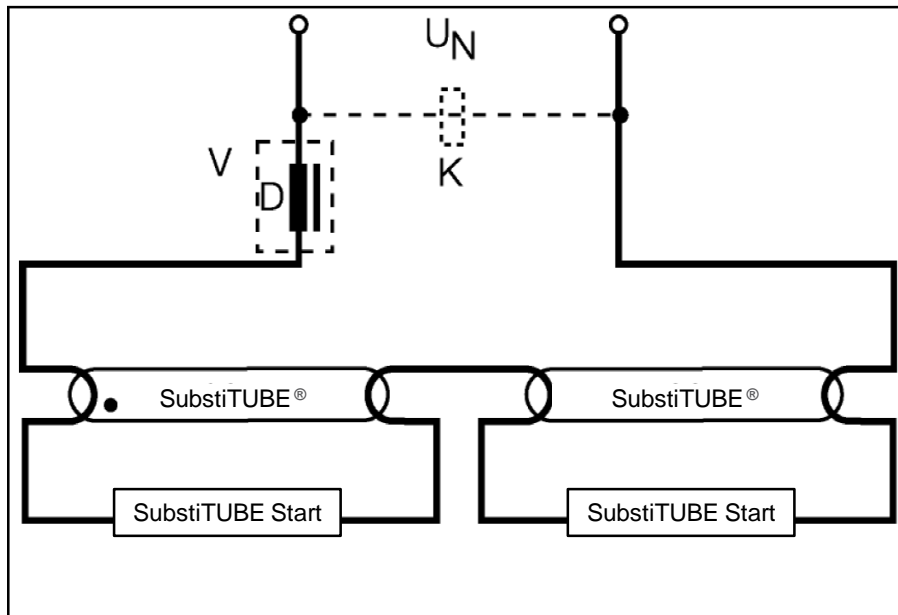

2. EM-Types

2.2 Conversion / Direct Wiring

2.2.1 Direct line voltage connection

SubstiTUBE® EM products can be operated at direct mains voltage 220V-240V. To eliminate remaining losses in CCG luminaires it is also possible to convert those fittings for direct mains operation with **SubstiTUBE**® EM. Conversion must be done according to below description in 2.2.2 “Sample installation direct wiring”.

Rewire a luminaire on both sides as shown below. Thus **SubstiTUBE**® EM can be inserted in any direction with standardized IEC compliant G13 lamp holders. All wires need to be approved for the existing voltages and appliance class. Usually solid wires with single isolation can be used for class I, double insulation wires could be used for class II. The maximum wire cross-section for lamp holders and starters is typically 0.5mm². Built-in control gears must not remain connected after rewiring.

Direct wiring circuit diagram of a retrofitted luminaire

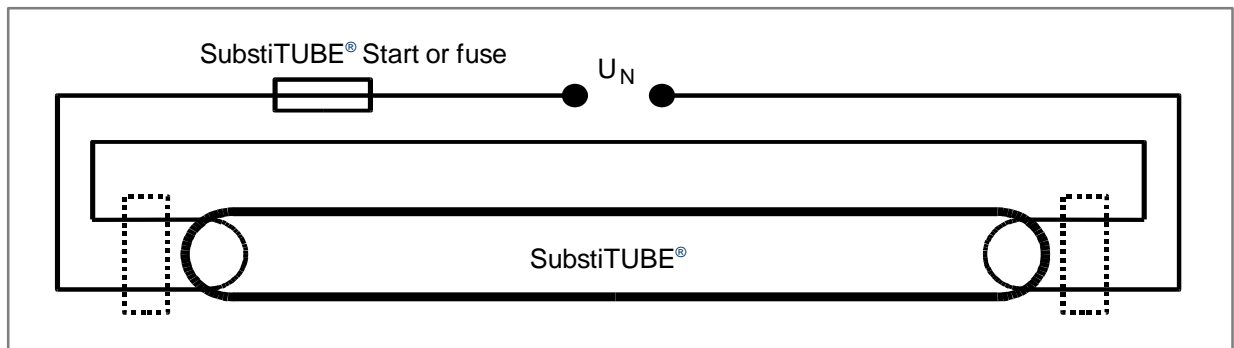

2. EM-Types

2.2 Conversion / Direct Wiring

Installation instruction:

Note: Rewiring by qualified electricians only.

- Make sure that the supply voltage is disconnected
- Remove the conventional lamp
- Remove power factor correction capacitor (if installed) to improve power factor
- Rewire the luminaire as shown in the circuit diagram on the page before

Note: Use SubstiTUBE® Start or a fuse (250V, T2A).

- Insert **SubstiTUBE®** EM into lamp holders
- Make sure with appropriate tests, that the rewired luminaire complies to all relevant safety requirements and other applicable regulations, e.g. acc. to DIN VDE 0701-0702 or 2004/108/EC
- Mark rewired luminaire with new nameplate

Direct wiring circuit diagram of a retrofitted double lamp luminaire

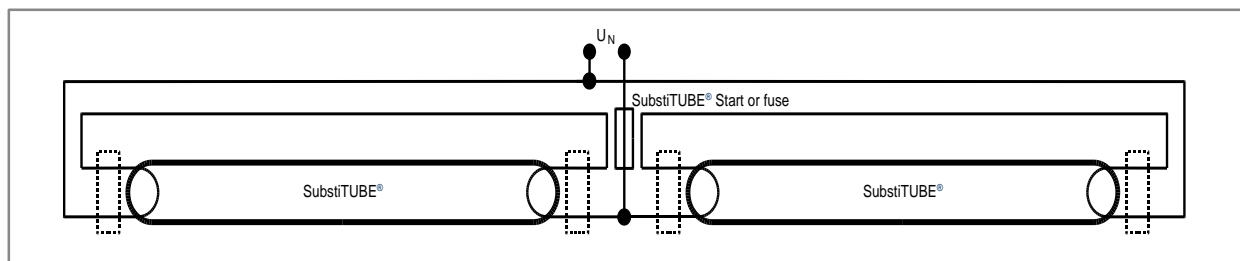

2. EM-Types

2.2 Conversion / Direct Wiring

2.2.2 Sample installation direct wiring

Direct wiring of a luminaire for **SubstiTUBE® EM** (control gear removed)

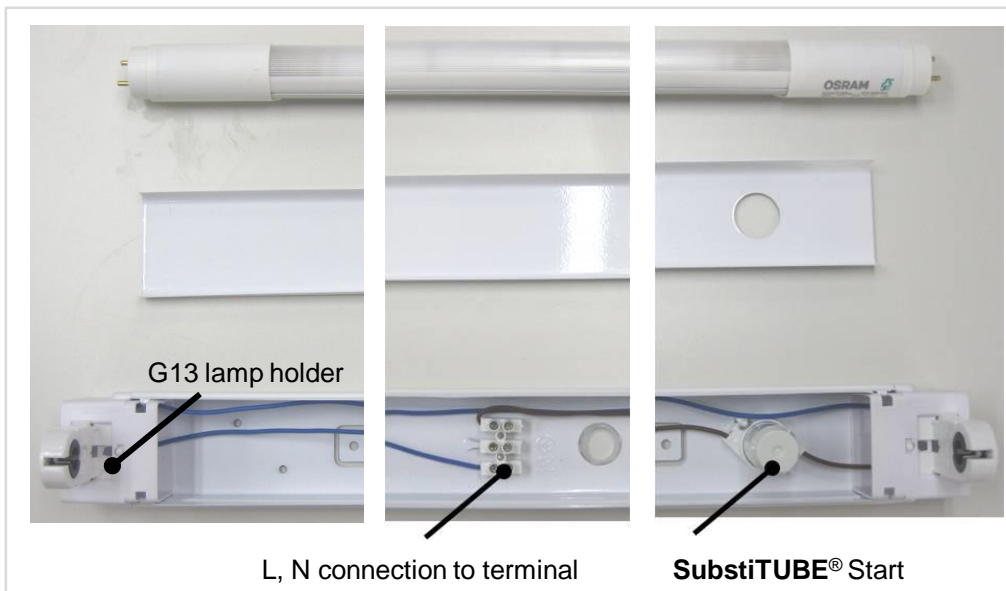

Make sure to modify the wiring completely, otherwise e.g. short circuits could lead to damage.



Example for an integrated holder for **SubstiTUBE® EM + Starter**



Example for terminal block with integrated fuseholder



3. HF-Types T8 and T5

3.1 Retrofitting in an ECG luminaire

3.1 Retrofitting in an ECG luminaire

Replacing the lamp is all that needs to be done to upgrade an existing luminaire with electrical control gear to newest OSRAM® HF-LED-technology. Since only the lamp is replaced, there is no constructive modification necessary to the luminaire. The **SubstiTUBE®** HF tube is compatible with ECGs of various brand manufacturers. For further information regarding the tested ECGs a compatibility list is available on www.ledvance.com/substiTUBE.

Energy consumption on ballast level will not be reduced by retrofitting, compared to a retrofitted CCG luminaire.

This is part of the new international safety norm IEC 62776

Circuit diagram of a retrofitted ECG luminaire

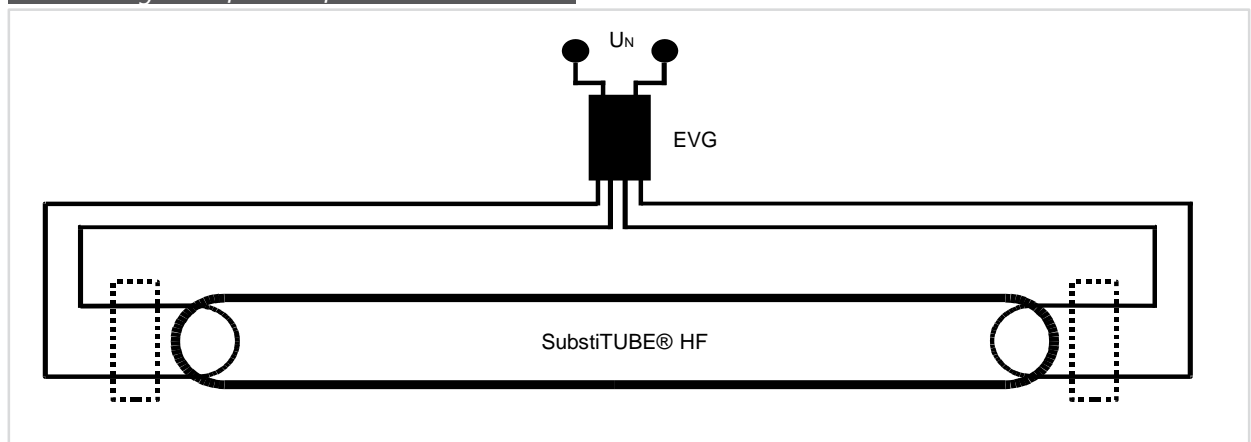

3. HF-Types T8 and T5

3.1 Retrofitting in an ECG luminaire

Retrofitting for common lamp holders

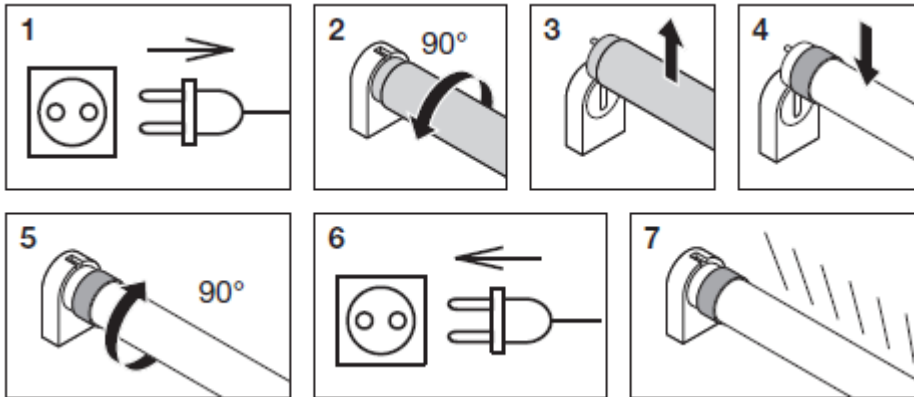

Please check ballast compatibility prior to installation
www.ledvance.com/substiTUBE.com

3. HF-Types T8 and T5

3.2 Multi circuit lamp luminaire

3.2 Multi circuit lamp luminaires

Double lamp luminaires can be retrofitted analogue to single lamp luminaires. Only the fluorescent lamps have to be replaced by **SubstiTUBE®** HF tubes. An example wiring for luminaires with OSRAM® ECGs is shown below.

Circuit diagram of a retrofitted double lamp ECG luminaire

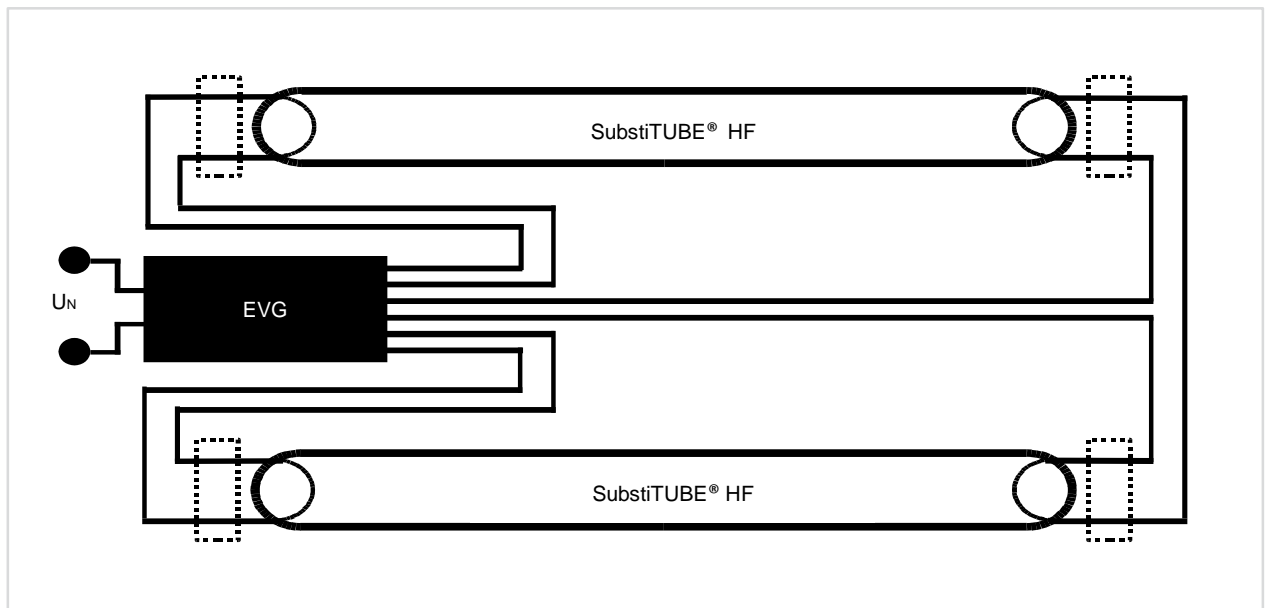

ECG luminaires with more than two lamps are wired similarly.

However, the wiring of the luminaire remains the same after retrofitting with **SubstiTUBE®** HF.

4. Universal-Types

4.1 Retrofitting in a CCG luminaire

4.1 Retrofitting in a CCG luminaire

Please follow instructions on page 6

4.1.1 Luminaires with compensating capacitor

Please follow instructions on page 7 (2.1.2)

4.2 Retrofitting in a ECG luminaire

4.2 Retrofitting in a ECG luminaire

Please follow instructions on pages 12 - 13

4.3 Conversion / Direct Wiring

4.3 Conversion / Direct Wiring

Please follow instructions on pages 9 - 11

5. AC-Types T5

5.1 Conversion / Direct Wiring

5.1.1 Direct line voltage connection

SubstiTUBE® T5 AC can only be operated in line voltage (220-240V) AC.

Thus **SubstiTUBE®** T5 AC can be inserted in any direction with standardized IEC compliant G5 lamp holders. All wires need to be approved for the existing voltages and appliance class. Usually solid wires with single isolation can be used for class I, double insulation wires could be used for class II. The maximum wire cross-section for lamp holders and starters is typically 0.5mm². Built-in control gears must not remain connected after rewiring.

Direct wiring circuit diagram of a retrofitted luminaire

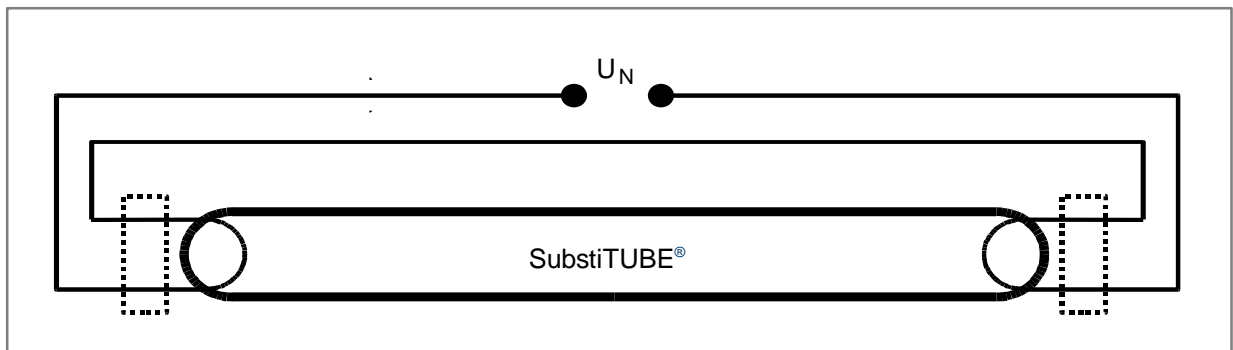

5. AC-Types T5

5.1 Conversion / Direct Wiring

Installation instruction:

Note: Rewiring by qualified electricians only.

- Make sure that the supply voltage is disconnected
- Remove the conventional lamp
- Remove power factor correction capacitor (if installed) to improve power factor
- Rewire the luminaire as shown in the circuit diagram on the page before

- Insert **SubstiTUBE**® T5 AC into lamp holders
- Make sure with appropriate tests, that the rewired luminaire complies to all relevant safety requirements and other applicable regulations, e.g. acc. to DIN VDE 0701-0702 or 2004/108/EC
- Mark rewired luminaire with new nameplate

Direct wiring circuit diagram of a retrofitted double lamp luminaire

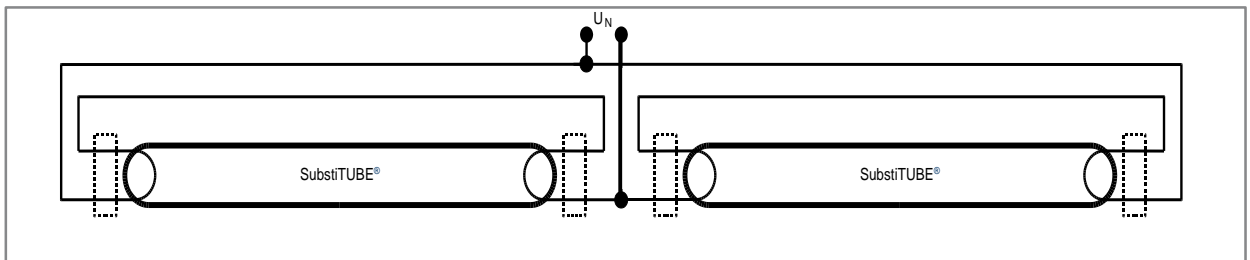

LEDVANCE GmbH

Parkring 29-33
85748 Garching/Munich
Germany

Telefon +49 89 6780673 100
Fax +49 89 6780673 101
Email contact@ledvance.com

www.ledvance.com

Disclaimer

All information contained in this document has been collected, analyzed and verified with great care by LEDVANCE. However, LEDVANCE is not responsible for the correctness and completeness of the information contained in this document and LEDVANCE cannot be made liable for any damage that occurs in connection with the use of and/or reliance on the content of this document. The information contained in this document reflects the current state of knowledge on the date of issue.